

Features

- Constant Gamma Abrupt Junction: 0.5
Hyperabrupt Junctions: 0.75, 1.25 and 1.5
- Low Cost
- Surface Mount Packages
- Very High Quality Factor
- Capacitance Ratio to 10:1
- Case Style 1056 is Hermetic and may be Screened to JANTX levels
- Tape and Reel Packaging Available

Description Applications

M/A-COM offers four families of low cost surface mount gallium arsenide tuning varactors. All families have silicon nitride protected junctions for low leakage current and high reliability.

The **MA46H500 through MA46H504** family has hyperabrupt junctions with constant gamma of 1.5 from 2 to 12 volts and high quality factor.

The **MA46H200 through MA46H204** family has hyperabrupt junctions with constant gamma of 1.25 from 2 to 20 volts and higher quality factor.

The **MA46H070 through MA46H073** family has hyperabrupt junctions with constant gamma of 0.75 from 0 to 20 volts and very high quality factor.

The **MA46504 through MA46506** family has abrupt junctions with constant gamma of 0.5 from 0 to 30 volts and the highest quality factor.

Applications

The **MA46H500 through MA46H504 (gamma 1.5)** family of constant gamma hyperabrupt GaAs tuning varactors is designed for wide bandwidth VCOs and voltage tuned filters where limited bias voltage is available. These varactors have lower quality factor than the other families of GaAs varactors.

The **MA46H200 through MA46H204 (gamma 1.25)** family of constant gamma hyperabrupt GaAs tuning varactors has the largest capacitance ratio of the families of GaAs varactors and high quality factor. These diodes are very well suited for wide bandwidth VCOs and VTFs where the optimum combination of very wide tuning range and high quality

Absolute Maximum Ratings @ $T_A=+25^\circ\text{C}$

Parameter	Absolute Maximum	
	Case 1056	Case 1088
Operating Temperature	-65°C to +150°C	-65°C to +125°C
Storage Temperature	-65°C to +200°C	-65°C to +125°C
Reverse Voltage	Breakdown Voltage	
Forward Current	50mA @ 25°C	
Power Dissipation	50mW @ 25°C, derate linearly to 0mW at maximum operating temperature	

Common Case styles

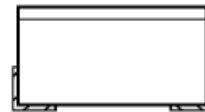

1056

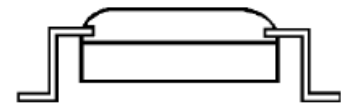

1088

PACKAGED TUNING VARACTOR EQUIVALENT CIRCUIT

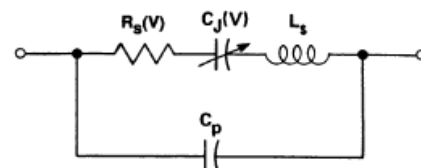

The **MA46H070 through MA46H073 (gamma 0.75)** family of constant gamma hyperabrupt GaAs tuning varactors has quality factor approaching that of abrupt junction varactors, but higher capacitance change versus tuning voltage. These diodes are very well suited for narrower bandwidth VCOs and VTFs where wide tuning range and very high quality factor are required.

The **MA46504 through MA46506 (gamma 0.5)** family of constant gamma abrupt GaAs tuning varactors has the highest quality factor. These diodes are very well suited for narrower bandwidth VCOs and VTFs where highest quality factor is of paramount concern

Electrical Specifications @ T_A = +25 °C

Gamma 0.5 Abrupt Tuning Varactors

Breakdown Voltage @ 10 μA = 30 V minimum
Reverse Current @ 24 V = 100 nA maximum
Gamma = 0.48 - 0.50, VR = 0 to 30 V

Part Number	Total Capacitance ^{2,3,5,7} +/-10%	Total Capacitance Ratio	Q Minimum
	Vr=4V	<u>Vr=0V</u> Vr=30V	Vr=4V f=50MHz
	(pF)	-	-
MA46504	0.5 - 0.7	2.1	6000
MA46505	0.9 - 1.1	2.8	5700

Electrical Specifications @ T_A = +25 °C

Gamma 0.75 Hyperabrupt Tuning Varactors

Breakdown Voltage @ 10 μA = 20 V minimum
Reverse Current @ 16 V = 100 nA maximum
Gamma = 0.68 - 0.83, VR = 0 to 20 V

Part Number	Total Capacitance ^{2,3,5,7} +/-10%	Total Capacitance Ratio	Q Minimum
	Vr=4V	<u>Vr=0V</u> Vr=20V	Vr=4V f=50MHz
	(pF)	-	-
MA46H070	0.5 - 0.7	5.5	4500
MA46H071	0.9 - 1.1	6.4	4500
MA46H072	2.7 - 3.3	7.5	3000
MA46H073	4.5 - 5.5	7.5	2200

Electrical Specifications @ T_A = +25 °C

Gamma 1.25 Hyperabrupt Tuning Varactors

Breakdown Voltage @ 10 μA = 22 V minimum
Reverse Current @ 16 V = 100 nA maximum
Gamma = 1.13 - 1.38, VR = 2 to 20 V

Part Number	Total Capacitance ^{2,3,5,7} +/-10%	Total Capacitance Ratio	Q Minimum
	Vr=4V	<u>Vr=2V</u> Vr=20V	Vr=4V f=50MHz
	(pF)	-	-
MA46H200	0.5-0.7	3	3000
MA46H201	0.9-1.1	4.1	3000
MA46H202	2.7-3.3	5.6	2000
MA46H203	4.5-5.5	10	1500
MA46H204	9-11	10	1500

Electrical Specifications @ T_A = +25 °C

Gamma 1.5 Hyperabrupt Tuning Varactors

Breakdown Voltage @ 10μA = 18 V minimum
Reverse Current @ 14 V = 100 nA maximum
Gamma = 1.4 - 1.6, VR = 2 to 12 V

Part Number	Total Capacitance ^{2,3,5,7} +/-10%	Total Capacitance Ratio	Q Minimum
	Vr=4V	<u>Vr=2V</u> Vr=12V	Vr=4V f=50MHz
	(pF)	-	-
MA46H500	0.5-0.7	2.8	2500
MA46H501	0.9-1.1	3.9	2500
MA46H503	4.5-5.5	8.1	1200
MA46H504	9-11	8.1	1200

Notes:

1. Case parasitics (Cp and Ls) are given for most case styles along with case outlines in the appendix. The Cp values listed typically have tolerances of ±0.02 pF.
2. The values guaranteed for gamma are measured on unpackaged chips. The total capacitance versus bias voltage curve will deviate slightly from the chip capacitance versus bias voltage curve due to the package parasitic capacitance (Cp).
3. Capacitance is measured at 1 MHz.
4. Reverse voltage (VR) is measured at 10 microamps.
5. The total capacitance and capacitance ratios shown are for diodes housed in case style 30. Other case styles will result in different values.

Specifications Subject to Change Without Notice.

Typical Performance Curves

Capacitance vs Reverse Voltage

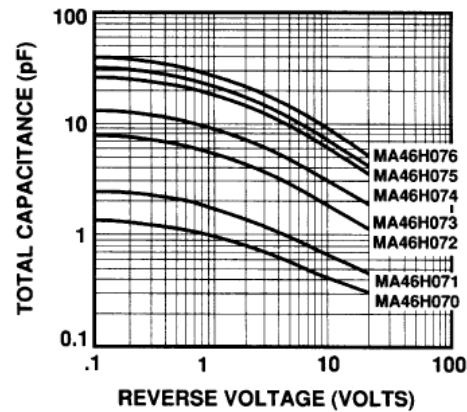
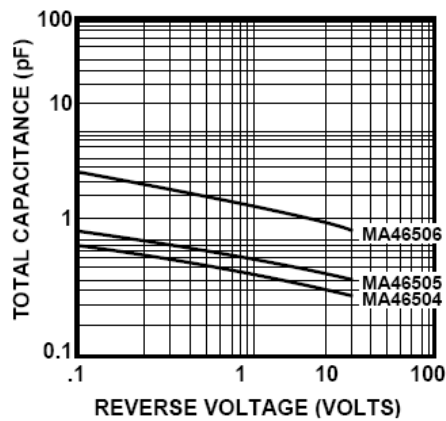
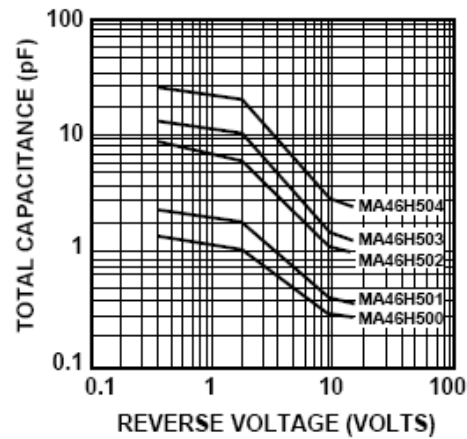
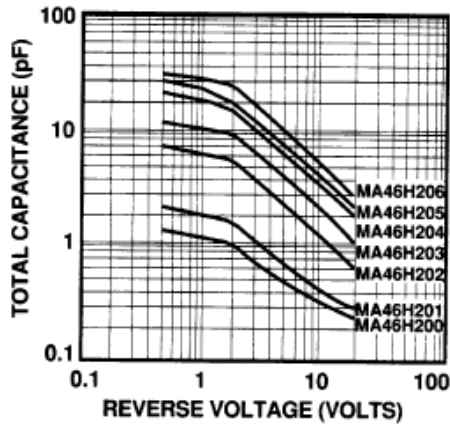

Temperature Coefficient of Capacitance vs Reverse Voltage

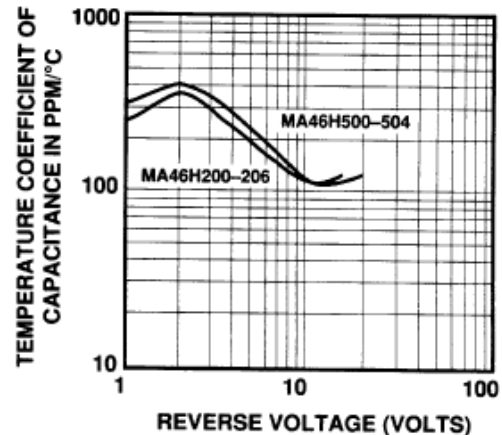
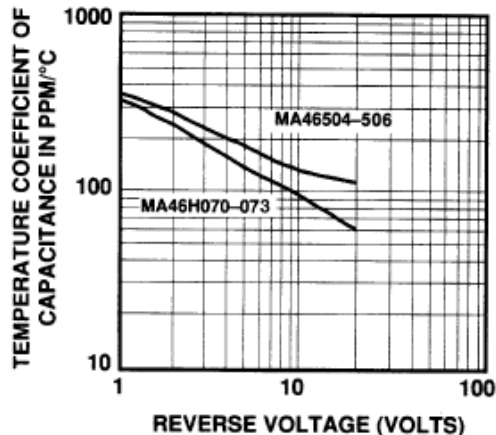

Case Styles

ODS-1056

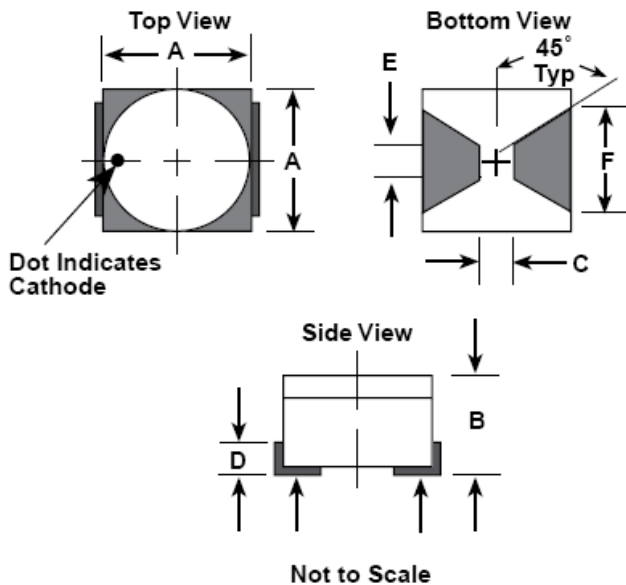

DIM.	INCHES		MILLIMETERS	
	MIN.	MAX.	MIN.	MAX.
A	0.065	0.075	1.72	1.90
B	0.034	0.041	0.86	1.04
C	0.030	0.036	0.76	0.91
D	0.013	0.017	0.33	0.44
E	0.010	0.014	0.25	0.36
F	0.043	0.053	1.09	1.35

Package Capacitance: 0.15 pF Typical
Package Inductance: 0.45 nH Typical

ODS-1088

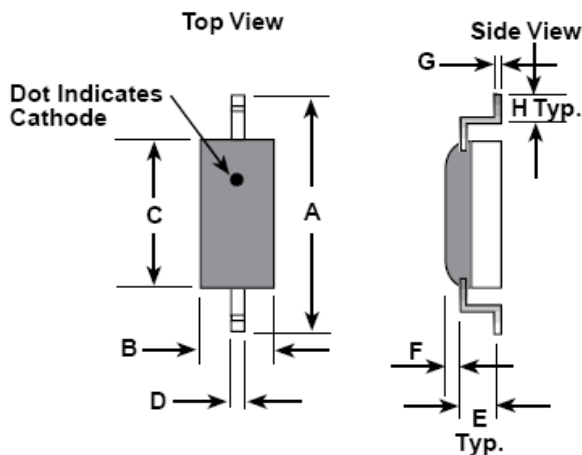

DIM.	INCHES		MILLIMETERS	
	MIN.	MAX.	MIN.	MAX.
A	0.175	0.195	4.44	4.95
B	0.040	0.050	1.02	1.27
C	0.085	0.095	2.16	2.41
D	0.015	0.025	0.38	0.64
E	0.010	0.015	0.25	0.38
F	0.015	0.020	0.38	0.51
G	0.004	0.006	0.10	0.15
H	0.020	0.030	0.51	0.76
J	0.013	0.033	0.33	0.84
K	0.003	0.005	0.08	0.13

Package Capacitance: 0.13 pF Typical
Package Inductance: 0.50 nH Typical

Ordering Information

These GaAs tuning varactors are available in either case style as shown. When ordering, specify the desired case style by adding the case designation as a suffix to the model number. For example, a MA46H200-1088 specifies a 1.25 gamma hyperabrupt tuning diode in case style 1088.